



*Taking you higher*

# ELEVATOR COMPONENTS

Disclaimer - Designer / Images / Specifications / Colors can vary from the actual product installed.

## CORPORATE OFFICE:

635, Mistry Building, 2nd Floor,  
Jagannath Shankarsheth Road,  
Mumbai - 400 002, India.

Phone - +91 22 22067503 / 22000816

Fax - +91 22 22000804

email - [concele@vsnl.com](mailto:concele@vsnl.com)

[info@concordelevator.co.in](mailto:info@concordelevator.co.in)

[www.concordelevator.in](http://www.concordelevator.in)

[www.concordelevator.co.in](http://www.concordelevator.co.in)



*Taking you higher*

# MACHINES AND CONTROLS







CONCORD ELEVATOR PVT LTD was established in January 1993 by our founder Chairman & Managing Director Mr. D.F. Palkhivala, whose experience in the Elevator Industry is since the year 1958.

CONCORD'S strong commitment to EXCELLANCE IN DESIGN AND PERFORMANCE through CONCORD'S in-house design, development and manufacturing programme for Elevator Component CONCORD today manufactures a wide range of elevators products, as follows:

1. **CONCORD HEAVY DUTY SIDE SLIDING AUTOMATIC DOOR SYSTEMS** - CONCORD automatic door systems are heavy-duty elevator AC VVVF door systems, cover a wide range of openings of 700mm wide X 2000mm high to 5000mm wide X 5000mm high. The CONCORD heavy-duty elevator door automatic door systems are available in an unimaginable range of finishes of Mild Steel in prime/ paint / powder coated finishes; Stainless Steel in hair line / natural mirror / colour mirror / natural etched / colour etched; full glass panels / frame glass panels.
2. **CONCORD FIXTURES** - CONCORD fixtures are cost effective fixtures available in two shapes – Round (32mm dia) buttons and Square elegant & large buttons (44mm sq) with a range of displays – Segment displays, Dotmatrix displays, LCD displays and also Plasma displays.
3. **CONCORD CAR & COUNTERWEIGHT FRAME SET** - CONCORD car & counterweight frame set are designed for elevators with payload capacities ranging from 204Kg to 5000Kg with instantaneous / progressive safety gear for travel speed from 0.20 M/Sec to 2.50 M/Sec and a wide range of guide shoes to chose from.  
CONCORD also has a wide range of "L" car frame with payload capacities ranging from 204Kg to currently 1000Kg with instantaneous / progressive safety gear for travel speed from 0.20 M/Sec to 1.0 M/Sec
4. **CONCORD MANUALLY OPERATED DOORS** - CONCORD manually doors side sliding two panel telescopic doors and CONCORD manually operated Swing doors, both available in Mild Steel in prime/ paint / powder coated finishes and in Stainless Steel in hair line finish.
5. **CONCORD TRADE** - CONCORD component trading division will configure and procure elevators components internationally for your specific elevator component requirements.  
CONCORD trading division will configure and procure complete Escalators, walkways / travolators, stair lifts for your requirements.



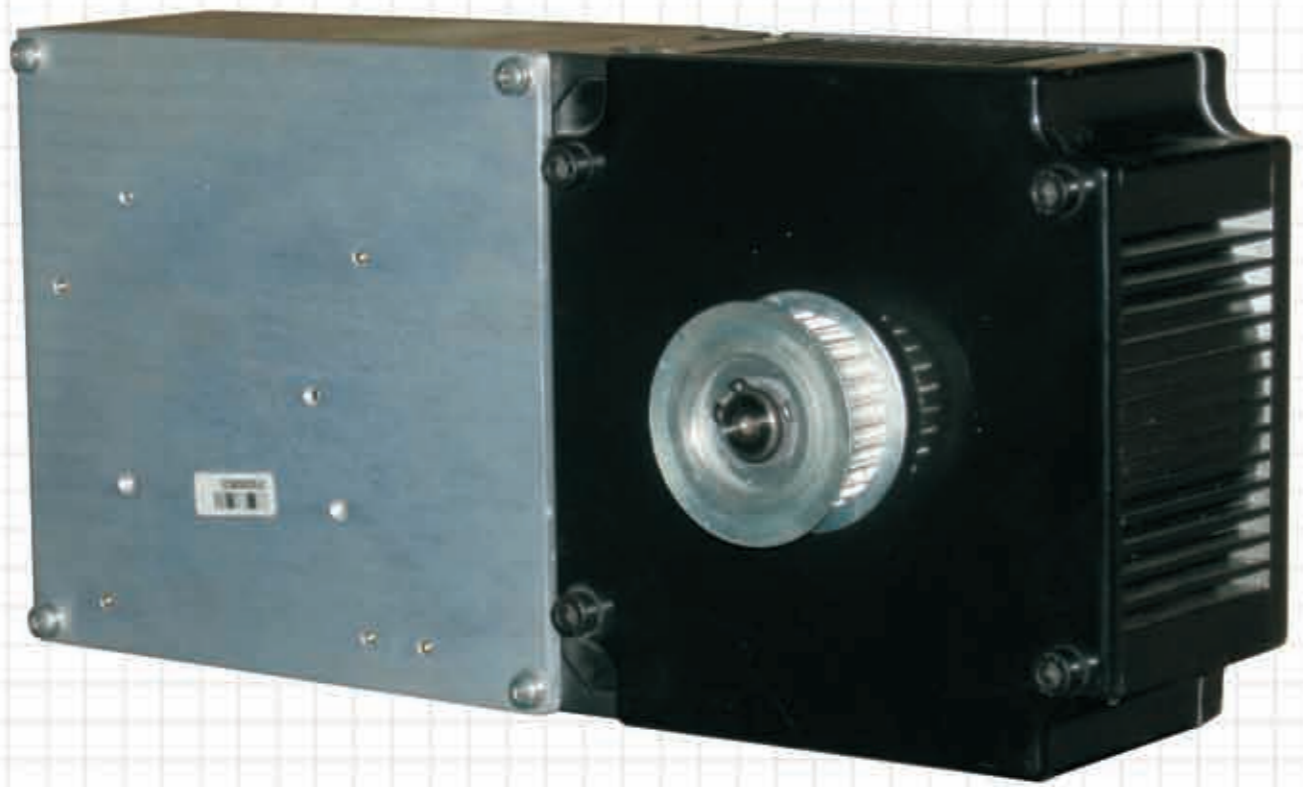

PMVF DOOR MOTOR  
AND DRIVE

High efficiency closed loop digital feedback permanent magnet. VVVF door system for smoother door operator

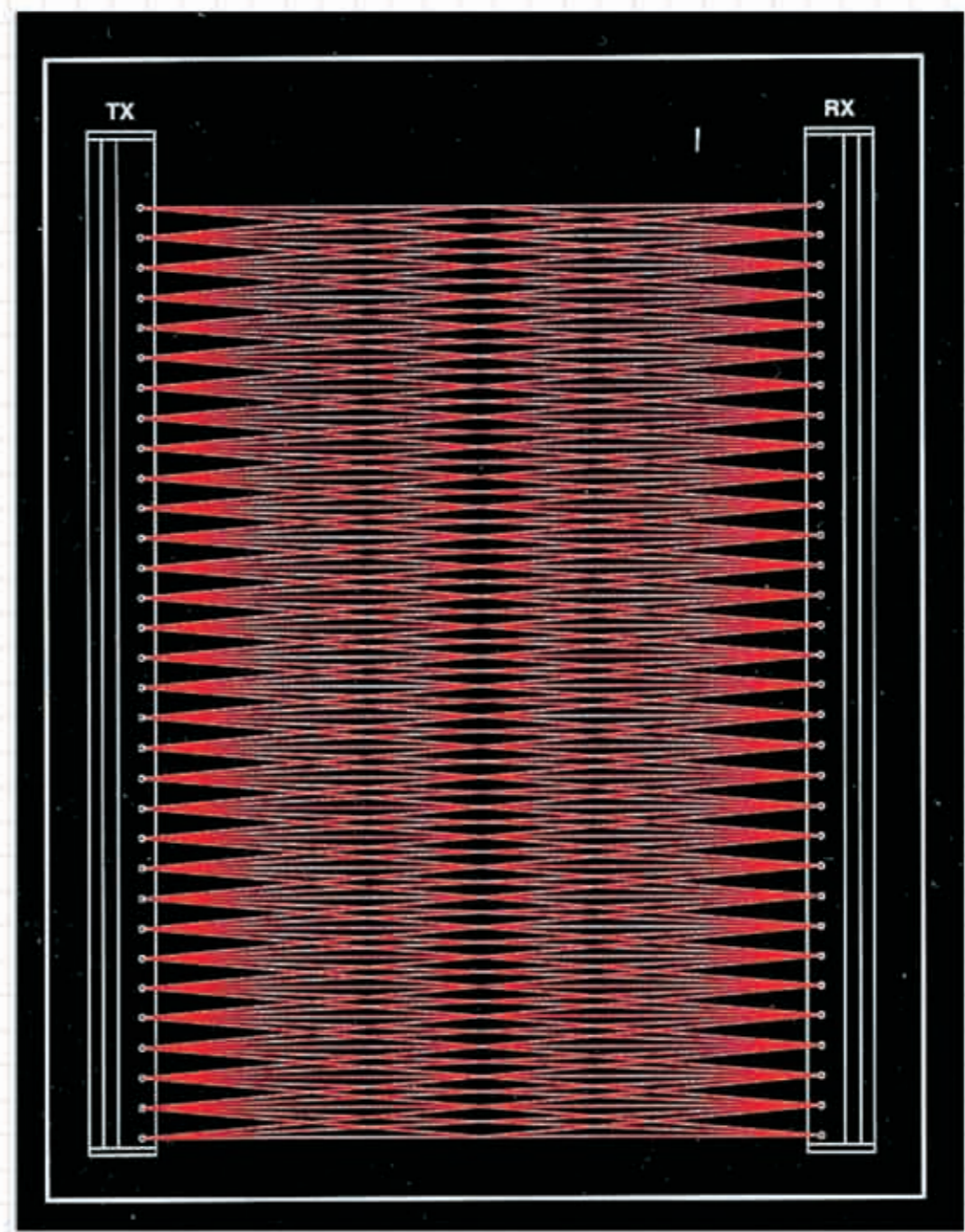

LIGHT CURTAIN  
DOOR SAFETY





MRL GEARLESS PERMANANT MAGNET TRACTION MACHINE

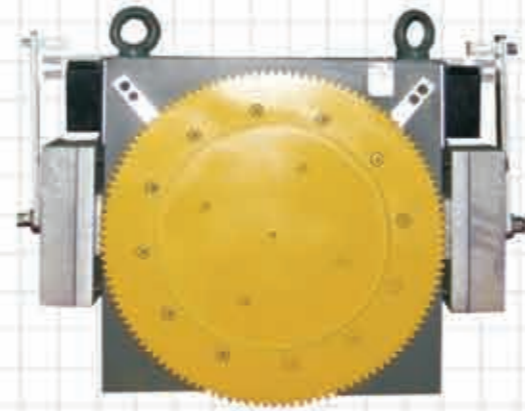

MRL GEARLESS PERMANANT MAGNET TRACTION MACHINE



MRL GEARLESS PERMANANT MAGNET TRACTION MACHINE



MRL Gearless machine (Type B)



INTELLIGENT 32 BIT MICRO CONTROLLER & IMPORTED AC VVVF OPEN LOOP / CLOSED LOOP DIGITAL FEEDBACK DRIVE BASED CONTROL SUITABLE FOR MACHINE ROOM APPLICATION



INTELLIGENT 32 BIT MICROCONTROLLER BASED & IMPORTED AC VVVF CLOSED LOOP DIGITAL FEEDBACK VECTOR DRIVE BASED CONTROL WITH BUILT IN AUTOMATIC RESCUE DEVICE FOR GEARLESS MACHINE SUITABLE FOR MRL ELEVATORS



3.0 M/SEC



7.0 M/SEC

HIGH SPEED EFFICIENT AND SMOOTH AC GEARLESS MACHINES



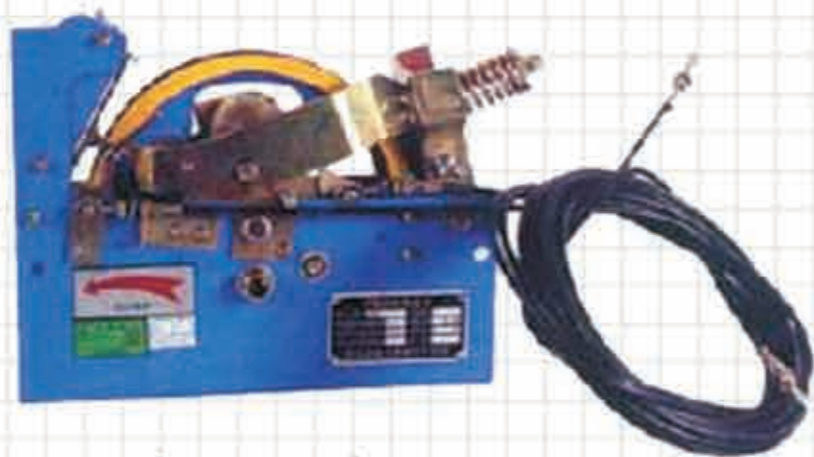

Machine Roomless  
Governer

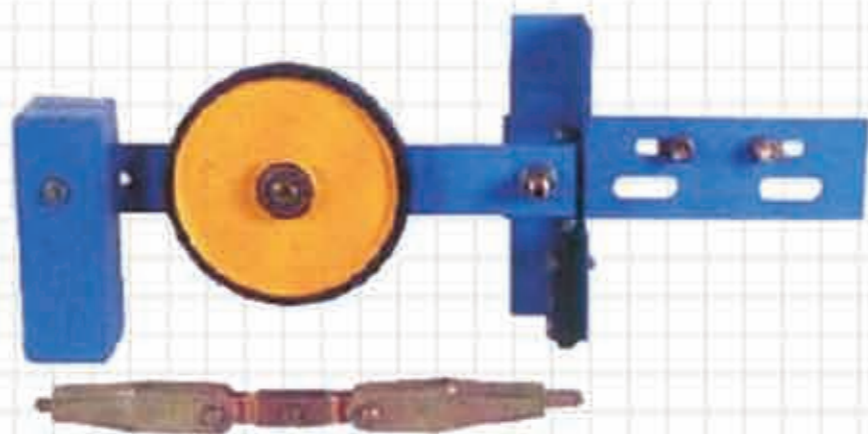

Progressive Safeties

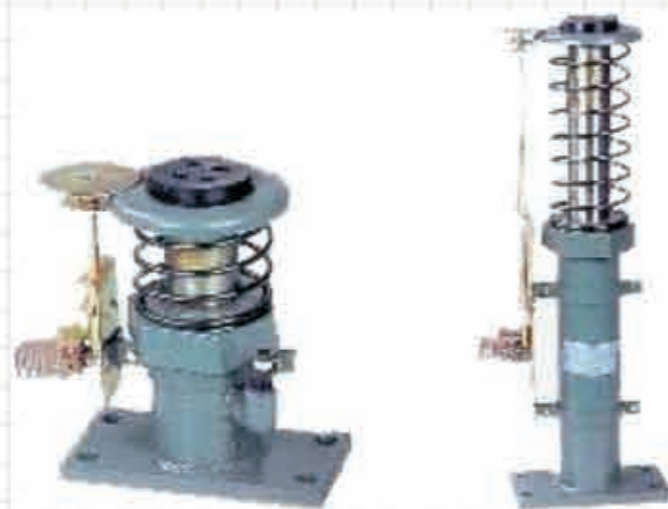

Hydraulic Buffers

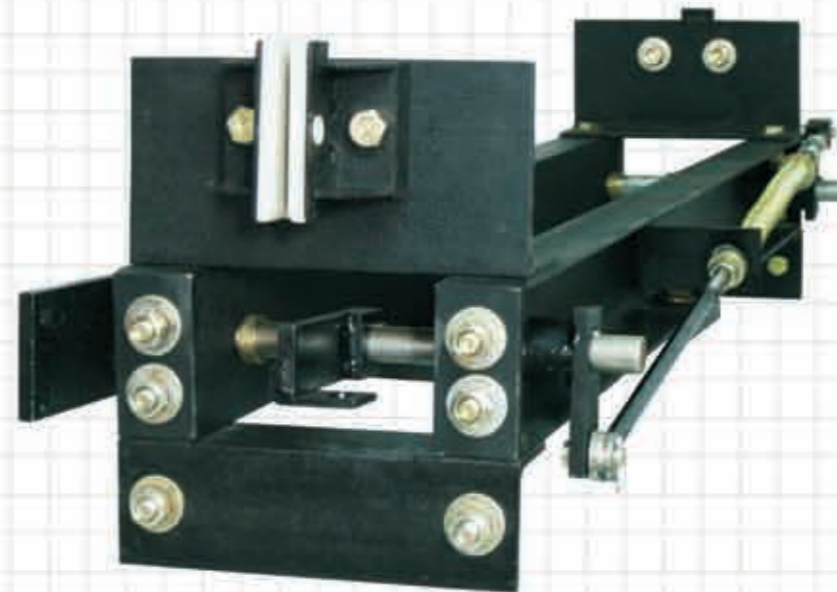

Standard Car Frame



Cross Head with safety mechanism link Assembly

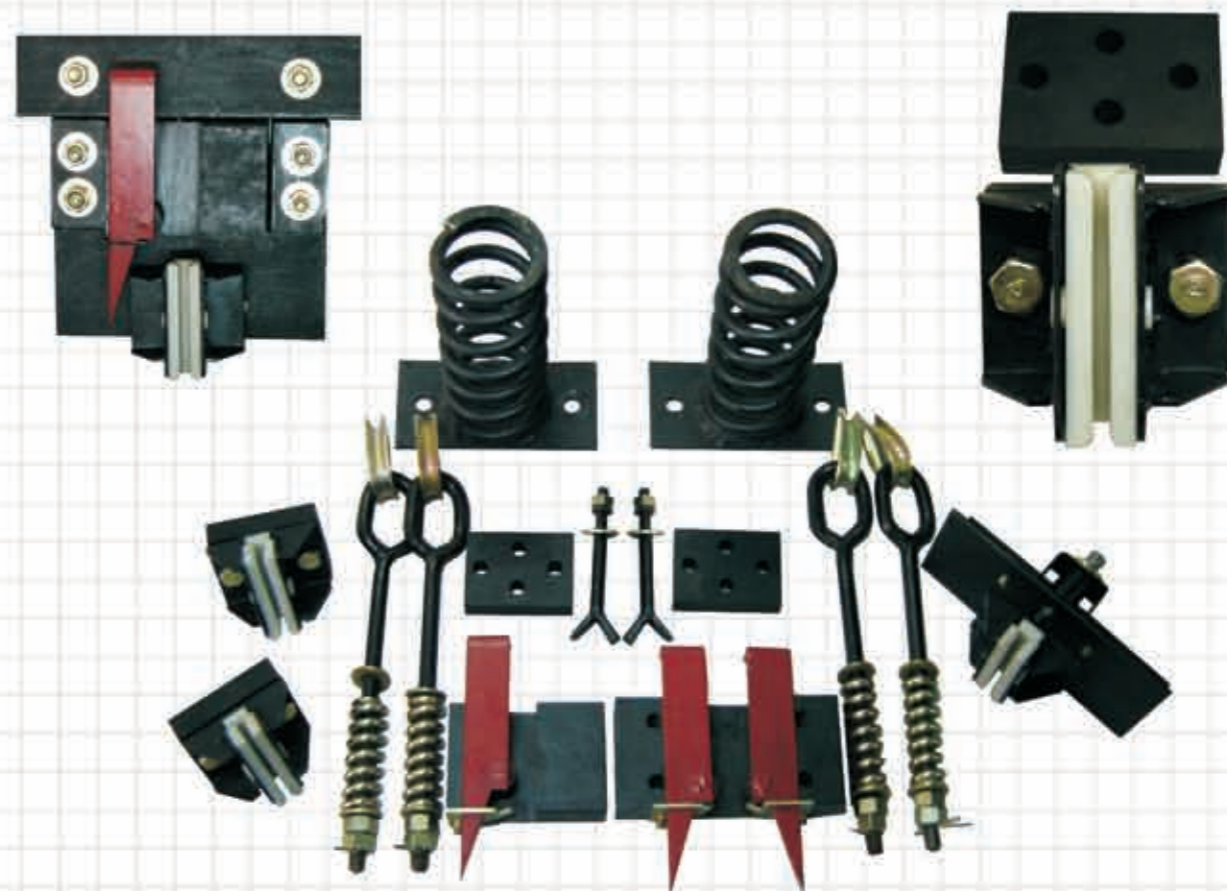

Car Frame Accessories



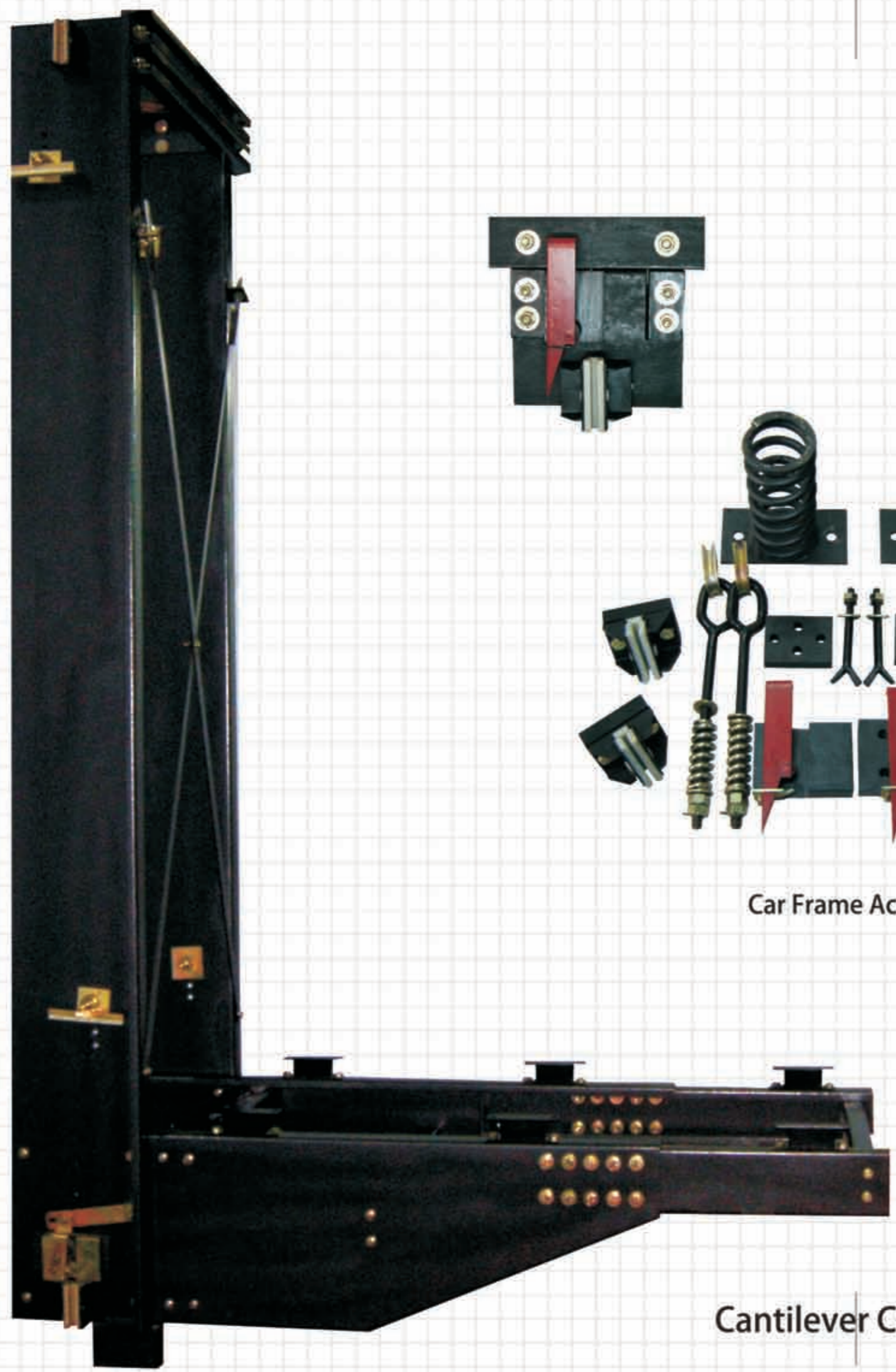

Cantilever Car Frame

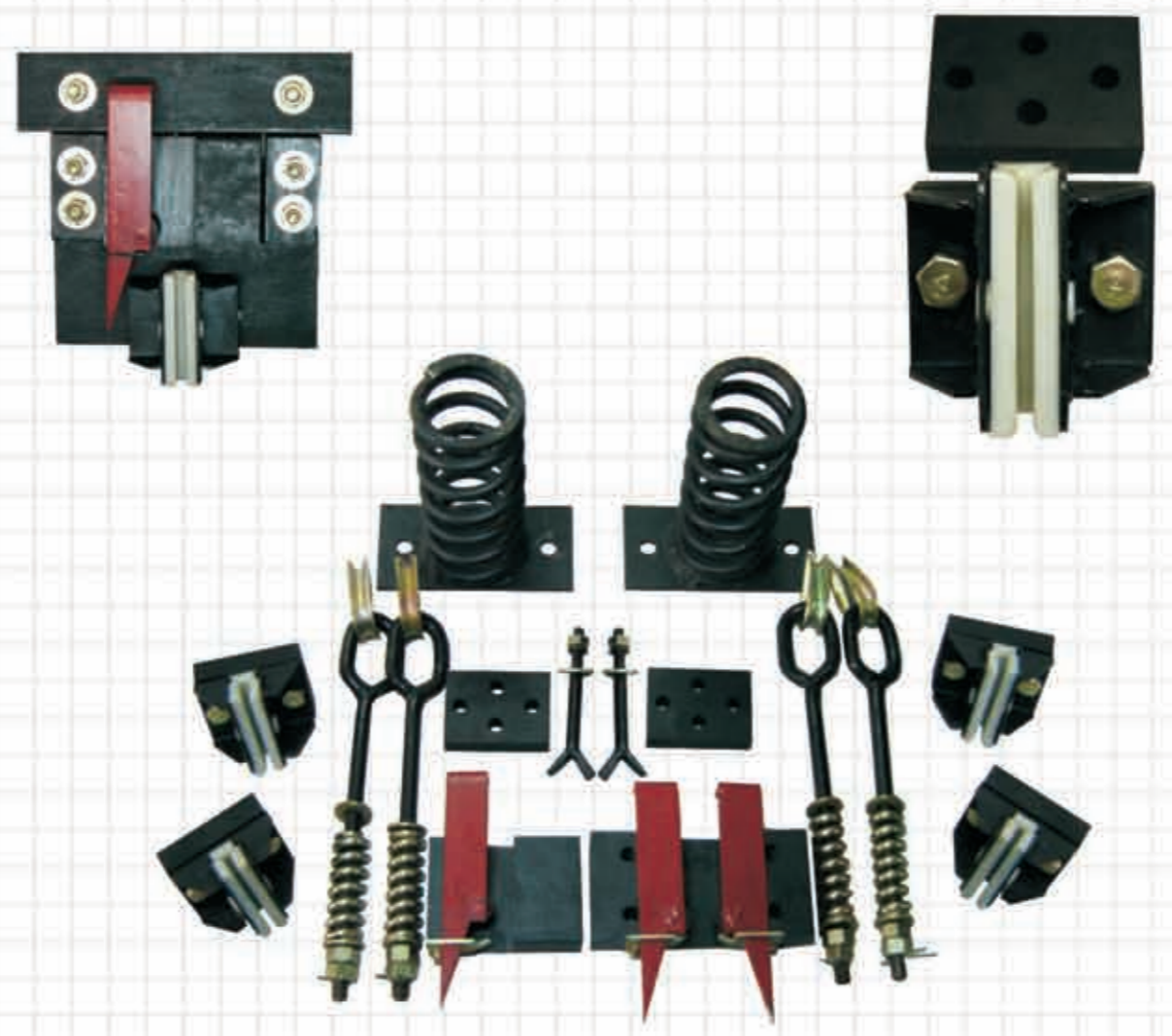

Car Frame Accessories

